Easy to Win, Hard to Master: Optimal Strategies in Parity Games with Costs

Joint work with Martin Zimmermann

Alexander Weinert

Saarland University

August 31st, 2016

CSL 2016 - Marseille, France

Parity Games

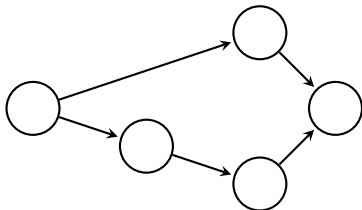

Example due to (Fijalkow and Chatterjee, Infinite-state games, 2013)

Parity Games

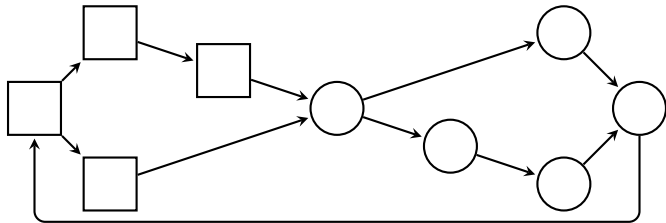

Example due to (Fijalkow and Chatterjee, Infinite-state games, 2013)

Parity Games

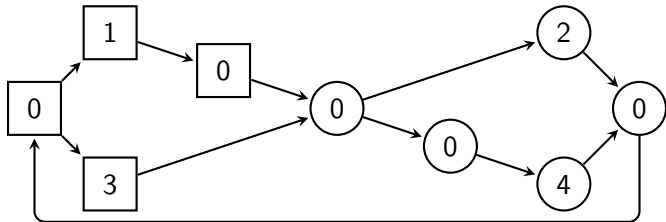

Example due to (Fijalkow and Chatterjee, Infinite-state games, 2013)

Parity Games

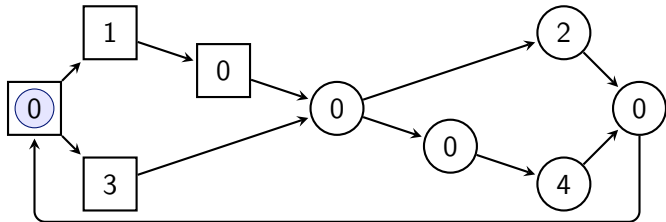

0

Example due to (Fijalkow and Chatterjee, Infinite-state games, 2013)

Parity Games

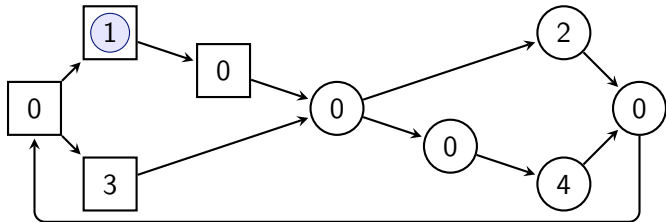

$0 \rightarrow 1$

Example due to (Fijalkow and Chatterjee, Infinite-state games, 2013)

Parity Games

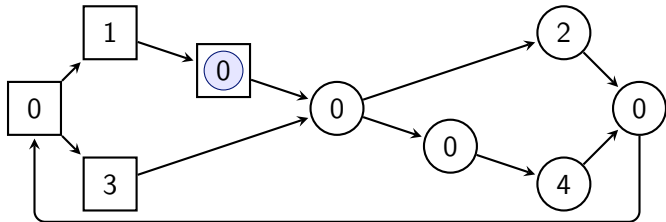

$0 \rightarrow 1 \rightarrow 0$

Example due to (Fijalkow and Chatterjee, Infinite-state games, 2013)

Parity Games

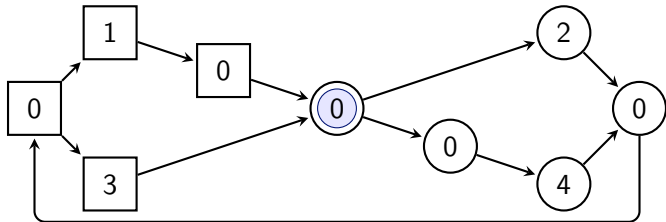

0 → 1 → 0 → 0

Example due to (Fijalkow and Chatterjee, Infinite-state games, 2013)

Parity Games

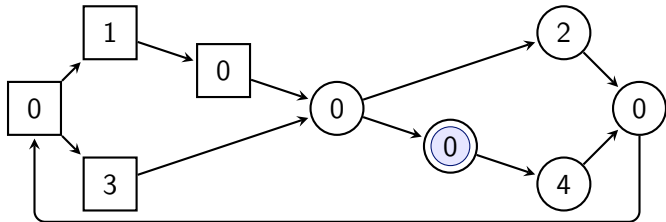

0 → 1 → 0 → 0 → 0

Example due to (Fijalkow and Chatterjee, Infinite-state games, 2013)

Parity Games

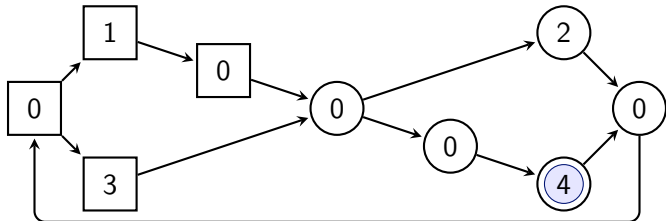

0 → 1 → 0 → 0 → 0 → 4

Example due to (Fijalkow and Chatterjee, Infinite-state games, 2013)

Parity Games

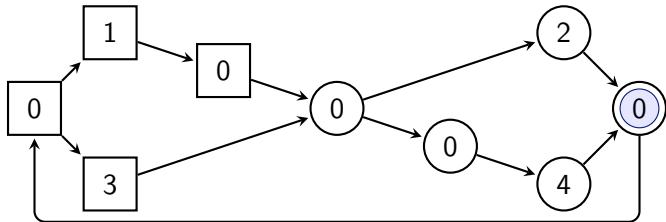

0 → 1 → 0 → 0 → 0 → 0 → 4 → 0

Example due to (Fijalkow and Chatterjee, Infinite-state games, 2013)

Parity Games

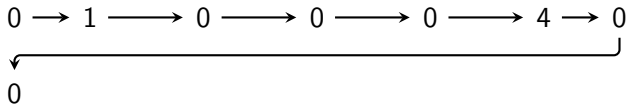
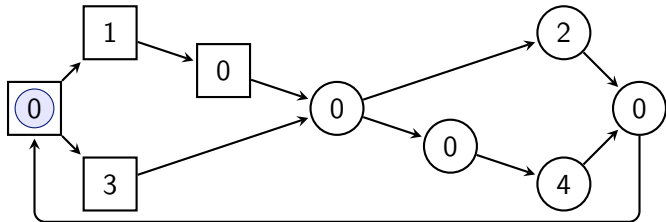

Example due to (Fijalkow and Chatterjee, Infinite-state games, 2013)

Parity Games

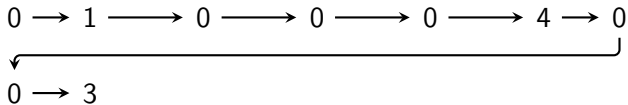
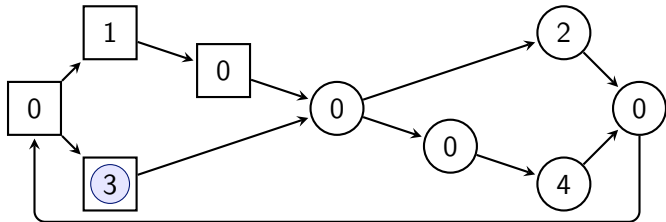

Example due to (Fijalkow and Chatterjee, Infinite-state games, 2013)

Parity Games

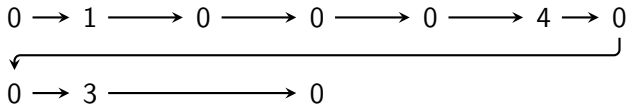
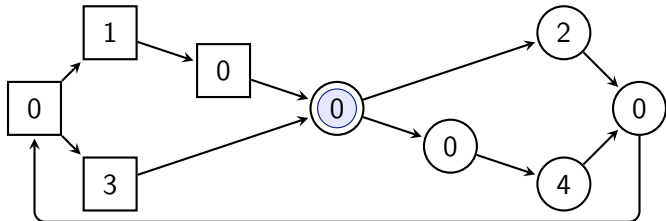

Example due to (Fijalkow and Chatterjee, Infinite-state games, 2013)

Parity Games

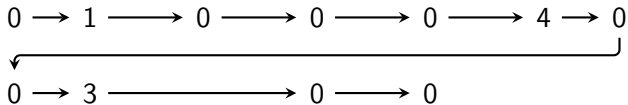
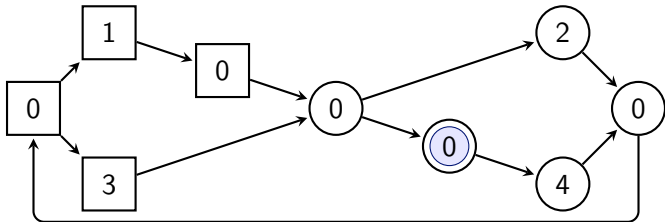

Example due to (Fijalkow and Chatterjee, Infinite-state games, 2013)

Parity Games

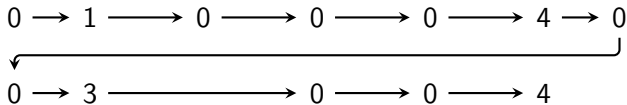
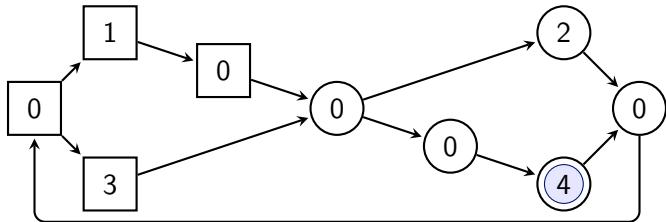

Example due to (Fijalkow and Chatterjee, Infinite-state games, 2013)

Parity Games

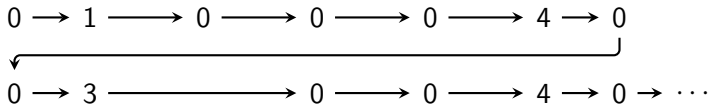
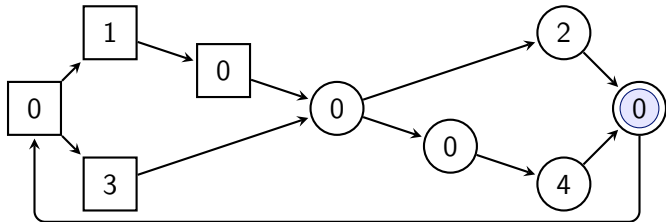

Example due to (Fijalkow and Chatterjee, Infinite-state games, 2013)

Parity Games

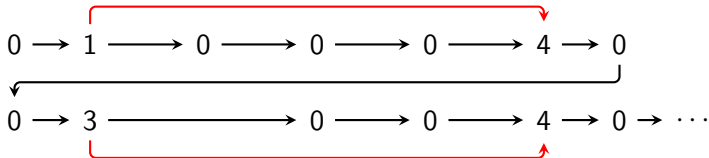
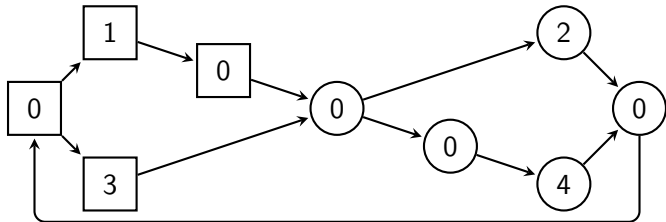

Example due to (Fijalkow and Chatterjee, Infinite-state games, 2013)

Parity Games

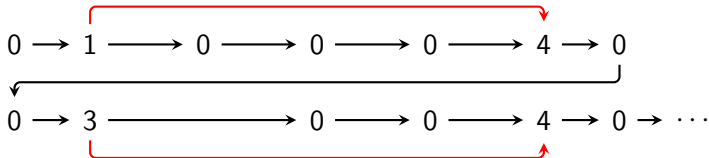
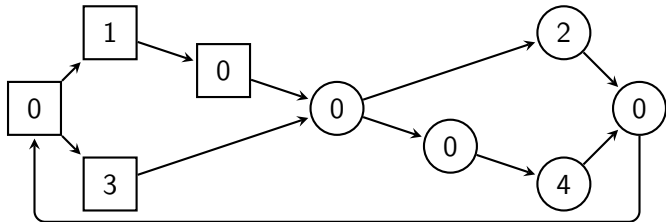

Deciding winner in $UP \cap co-UP$

Positional Strategies

Example due to (Fijalkow and Chatterjee, Infinite-state games, 2013)

Finitary Parity Games

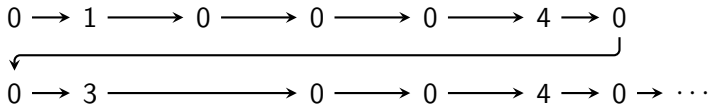
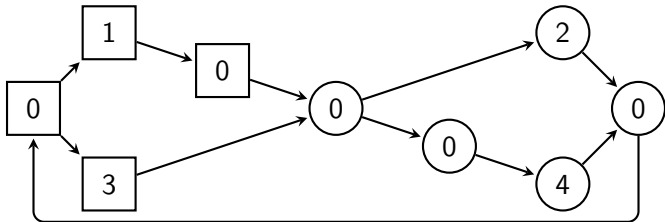

Example due to (Fijalkow and Chatterjee, Infinite-state games, 2013)

Finitary Parity Games

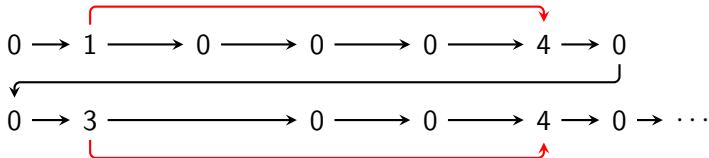
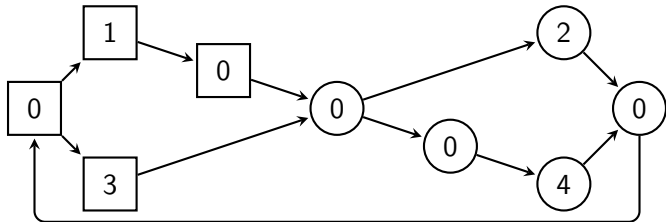

Example due to (Fijalkow and Chatterjee, Infinite-state games, 2013)

Finitary Parity Games

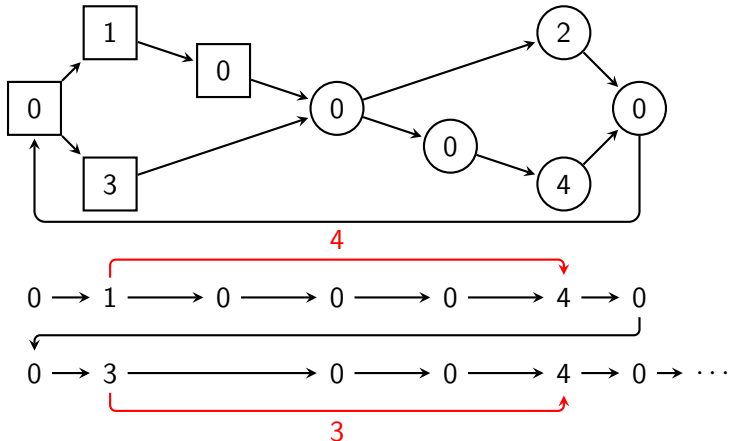

Example due to (Fijalkow and Chatterjee, Infinite-state games, 2013)

Finitary Parity Games

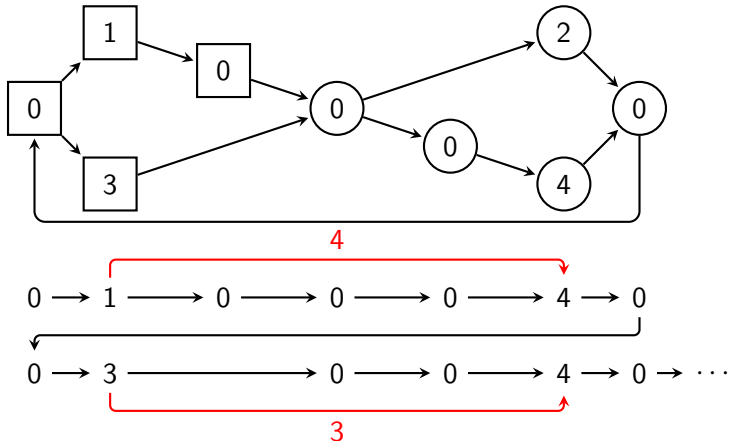

Goal for Player 0: Bound response times

Example due to (Fijalkow and Chatterjee, Infinite-state games, 2013)

Decision Problem

Theorem (Chatterjee et al., Finitary Winning, 2009)

The following decision problem is in PTIME:

Input: Finitary parity game $\mathcal{G} = (\mathcal{A}, \text{FinParity}(\Omega))$

Question: Does there exist a strategy σ with $\text{Cst}(\sigma) < \infty$?

Decision Problem

Theorem (Chatterjee et al., Finitary Winning, 2009)

The following decision problem is in PTIME:

Input: Finitary parity game $\mathcal{G} = (\mathcal{A}, \text{FinParity}(\Omega))$

Question: Does there exist a strategy σ with $\text{Cst}(\sigma) < \infty$?

Theorem

The following decision problem is PSPACE-complete:

Input: Finitary parity game $\mathcal{G} = (\mathcal{A}, \text{FinParity}(\Omega))$,
bound $b \in \mathbb{N}$

Question: Does there exist a strategy σ with $\text{Cst}(\sigma) \leq b$?

Introduction

Introduction ✓

Introduction ✓



Complexity

in PSPACE

Introduction ✓



Complexity

in PSPACE

PSPACE-hard

Introduction ✓



Complexity

in PSPACE

PSPACE-hard



Exponential Memory

Sufficient

Introduction ✓



Complexity

in PSPACE

PSPACE-hard



Exponential Memory

Sufficient

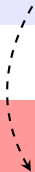

Introduction ✓



Complexity

in PSPACE

PSPACE-hard



Exponential Memory

Sufficient

Necessary

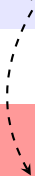

From Finitary Parity to Parity

Given: Finitary parity game $\mathcal{G} = (\mathcal{A}, \text{FinParity}(\Omega))$, bound $b \in \mathbb{N}$.

Lemma

Deciding if Player 0 has strategy σ with $\text{Cst}(\sigma) \leq b$ is in PSPACE.

From Finitary Parity to Parity

Given: Finitary parity game $\mathcal{G} = (\mathcal{A}, \text{FinParity}(\Omega))$, bound $b \in \mathbb{N}$.

Lemma

Deciding if Player 0 has strategy σ with $\text{Cst}(\sigma) \leq b$ is in PSPACE.

Idea: Simulate game, keeping track of open requests.

From Finitary Parity to Parity

Given: Finitary parity game $\mathcal{G} = (\mathcal{A}, \text{FinParity}(\Omega))$, bound $b \in \mathbb{N}$.

Lemma

Deciding if Player 0 has strategy σ with $\text{Cst}(\sigma) \leq b$ is in PSPACE.

Idea: Simulate game, keeping track of open requests.

Lemma

Player 0 has such a strategy iff she “survives” $p(|\mathcal{G}|)$ steps in extended game \mathcal{G}' .

From Finitary Parity to Parity

Given: Finitary parity game $\mathcal{G} = (\mathcal{A}, \text{FinParity}(\Omega))$, bound $b \in \mathbb{N}$.

Lemma

Deciding if Player 0 has strategy σ with $\text{Cst}(\sigma) \leq b$ is in PSPACE.

Idea: Simulate game, keeping track of open requests.

Lemma

Player 0 has such a strategy iff she “survives” $p(|\mathcal{G}|)$ steps in extended game \mathcal{G}' .

Algorithm:

Simulate all plays in \mathcal{G}' on-the-fly for $p(|\mathcal{G}|)$ steps

From Finitary Parity to Parity

Given: Finitary parity game $\mathcal{G} = (\mathcal{A}, \text{FinParity}(\Omega))$, bound $b \in \mathbb{N}$.

Lemma

Deciding if Player 0 has strategy σ with $\text{Cst}(\sigma) \leq b$ is in PSPACE.

Idea: Simulate game, keeping track of open requests.

Lemma

Player 0 has such a strategy iff she “survives” $p(|\mathcal{G}|)$ steps in extended game \mathcal{G}' .

Algorithm:

Simulate all plays in \mathcal{G}' on-the-fly for $p(|\mathcal{G}|)$ steps using an alternating Turing machine.

From Finitary Parity to Parity

Given: Finitary parity game $\mathcal{G} = (\mathcal{A}, \text{FinParity}(\Omega))$, bound $b \in \mathbb{N}$.

Lemma

Deciding if Player 0 has strategy σ with $\text{Cst}(\sigma) \leq b$ is in PSPACE.

Idea: Simulate game, keeping track of open requests.

Lemma

Player 0 has such a strategy iff she “survives” $p(|\mathcal{G}|)$ steps in extended game \mathcal{G}' .

Algorithm:

Simulate all plays in \mathcal{G}' on-the-fly for $p(|\mathcal{G}|)$ steps using an alternating Turing machine.

\Rightarrow Problem is in APTIME

From Finitary Parity to Parity

Given: Finitary parity game $\mathcal{G} = (\mathcal{A}, \text{FinParity}(\Omega))$, bound $b \in \mathbb{N}$.

Lemma

Deciding if Player 0 has strategy σ with $\text{Cst}(\sigma) \leq b$ is in PSPACE.

Idea: Simulate game, keeping track of open requests.

Lemma

Player 0 has such a strategy iff she “survives” $p(|\mathcal{G}|)$ steps in extended game \mathcal{G}' .

Algorithm:

Simulate all plays in \mathcal{G}' on-the-fly for $p(|\mathcal{G}|)$ steps using an alternating Turing machine.

⇒ Problem is in APTIME

(Chandra et al., Alternation, 1981)

⇒ Problem is in PSPACE

Introduction ✓



Complexity

in PSPACE

PSPACE-hard



Exponential Memory

Sufficient

Necessary

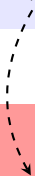

Introduction ✓



Complexity

in PSPACE ✓

PSPACE-hard



Exponential Memory

Sufficient

Necessary

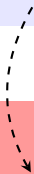

PSPACE-completeness

Lemma

The given decision problem is PSPACE-hard.

PSPACE-completeness

Lemma

The given decision problem is PSPACE-hard.

Idea: Reduction from Quantified Boolean Formulas, e.g.:

$$\forall x \exists y . (x \vee \neg y) \wedge (\neg x \vee y)$$

PSPACE-completeness

Lemma

The given decision problem is PSPACE-hard.

Idea: Reduction from Quantified Boolean Formulas, e.g.:

$$\forall x \exists y . (x \vee \neg y) \wedge (\neg x \vee y)$$

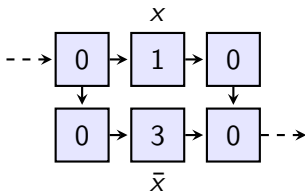

PSPACE-completeness

Lemma

The given decision problem is PSPACE-hard.

Idea: Reduction from Quantified Boolean Formulas, e.g.:

$$\forall x \exists y . (x \vee \neg y) \wedge (\neg x \vee y)$$

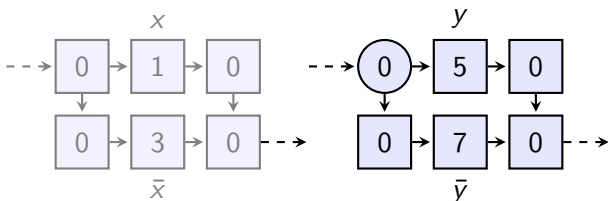

PSPACE-completeness

Lemma

The given decision problem is PSPACE-hard.

Idea: Reduction from Quantified Boolean Formulas, e.g.:

$$\forall x \exists y . (x \vee \neg y) \wedge (\neg x \vee y)$$

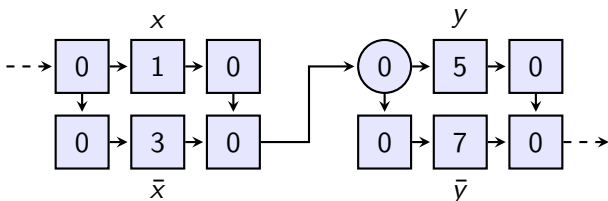

PSPACE-completeness

Lemma

The given decision problem is PSPACE-hard.

Idea: Reduction from Quantified Boolean Formulas, e.g.:

$$\forall x \exists y . (x \vee \neg y) \wedge (\neg x \vee y)$$

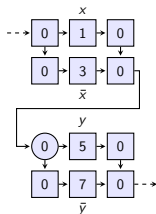

PSPACE-completeness

Lemma

The given decision problem is PSPACE-hard.

Idea: Reduction from Quantified Boolean Formulas, e.g.:

$$\forall x \exists y . (x \vee \neg y) \wedge (\neg x \vee y)$$

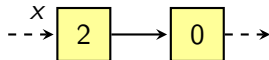
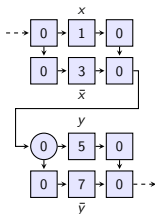

PSPACE-completeness

Lemma

The given decision problem is PSPACE-hard.

Idea: Reduction from Quantified Boolean Formulas, e.g.:

$$\forall x \exists y . (x \vee \neg y) \wedge (\neg x \vee y)$$

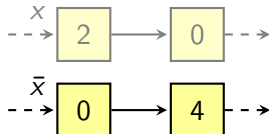
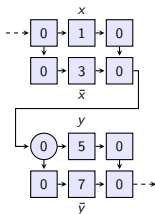

PSPACE-completeness

Lemma

The given decision problem is PSPACE-hard.

Idea: Reduction from Quantified Boolean Formulas, e.g.:

$$\forall x \exists y . (x \vee \neg y) \wedge (\neg x \vee y)$$

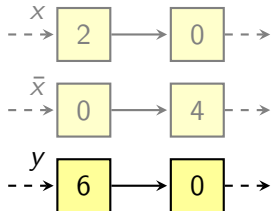
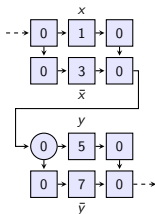

PSPACE-completeness

Lemma

The given decision problem is PSPACE-hard.

Idea: Reduction from Quantified Boolean Formulas, e.g.:

$$\forall x \exists y . (x \vee \neg y) \wedge (\neg x \vee y)$$

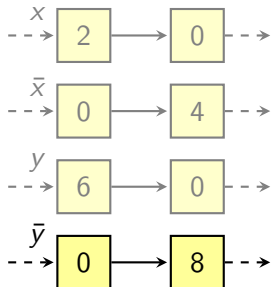
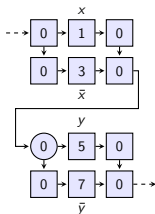

PSPACE-completeness

Lemma

The given decision problem is PSPACE-hard.

Idea: Reduction from Quantified Boolean Formulas, e.g.:

$$\forall x \exists y . (x \vee \neg y) \wedge (\neg x \vee y)$$

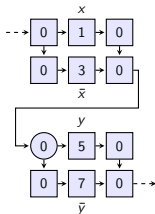

0

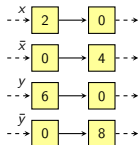

PSPACE-completeness

Lemma

The given decision problem is PSPACE-hard.

Idea: Reduction from Quantified Boolean Formulas, e.g.:

$$\forall x \exists y . (x \vee \neg y) \wedge (\neg x \vee y)$$

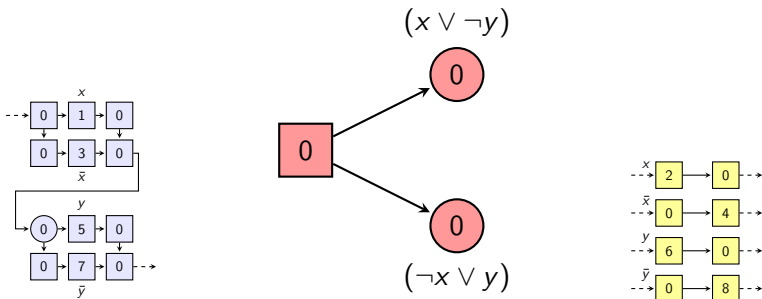

PSPACE-completeness

Lemma

The given decision problem is PSPACE-hard.

Idea: Reduction from Quantified Boolean Formulas, e.g.:

$$\forall x \exists y . (x \vee \neg y) \wedge (\neg x \vee y)$$

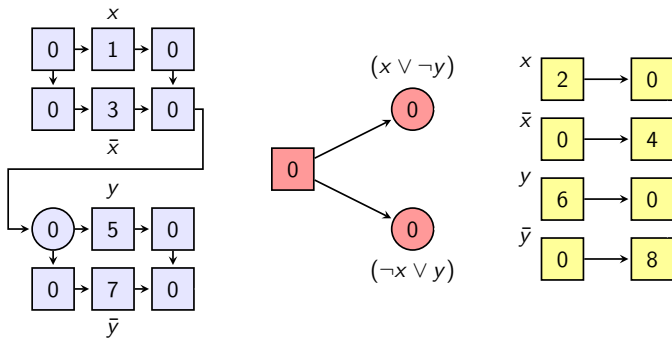

PSPACE-completeness

Lemma

The given decision problem is PSPACE-hard.

Idea: Reduction from Quantified Boolean Formulas, e.g.:

$$\forall x \exists y . (x \vee \neg y) \wedge (\neg x \vee y)$$

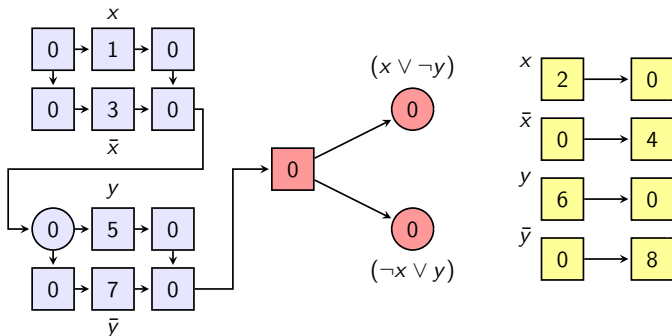

PSPACE-completeness

Lemma

The given decision problem is PSPACE-hard.

Idea: Reduction from Quantified Boolean Formulas, e.g.:

$$\forall x \exists y . (x \vee \neg y) \wedge (\neg x \vee y)$$

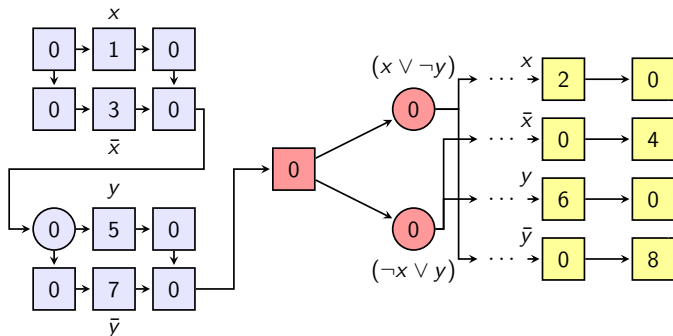

PSPACE-completeness

Lemma

The given decision problem is PSPACE-hard.

Idea: Reduction from Quantified Boolean Formulas, e.g.:

$$\forall x \exists y . (x \vee \neg y) \wedge (\neg x \vee y)$$

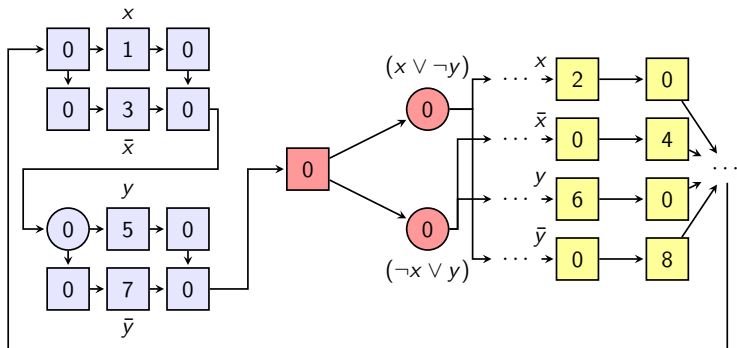

Introduction ✓



Complexity

in PSPACE ✓

PSPACE-hard



Exponential Memory

Sufficient

Necessary

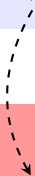

Introduction ✓



Complexity

in PSPACE ✓

PSPACE-hard ✓



Exponential Memory

Sufficient

Necessary

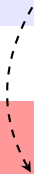

Memory Requirements (for Player 0)

Theorem

Optimal strategies for parity games require exponential memory.

Memory Requirements (for Player 0)

Theorem

Optimal strategies for parity games require exponential memory.

Sufficiency: Corollary of proof of PSPACE-membership

Memory Requirements (for Player 0)

Theorem

Optimal strategies for parity games require exponential memory.

Sufficiency: Corollary of proof of PSPACE-membership

Necessity: Construct family \mathcal{G}_d :

Memory Requirements (for Player 0)

Theorem

Optimal strategies for parity games require exponential memory.

Sufficiency: Corollary of proof of PSPACE-membership

Necessity: Construct family \mathcal{G}_d :

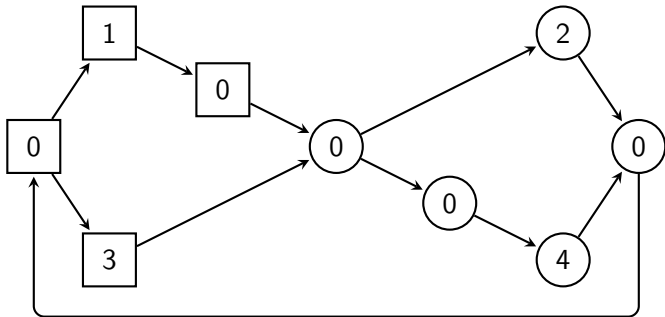

(Fijalkow and Chatterjee, Infinite-state games, 2013)

Memory Requirements (for Player 0)

Theorem

Optimal strategies for parity games require exponential memory.

Sufficiency: Corollary of proof of PSPACE-membership

Necessity: Construct family \mathcal{G}_d :

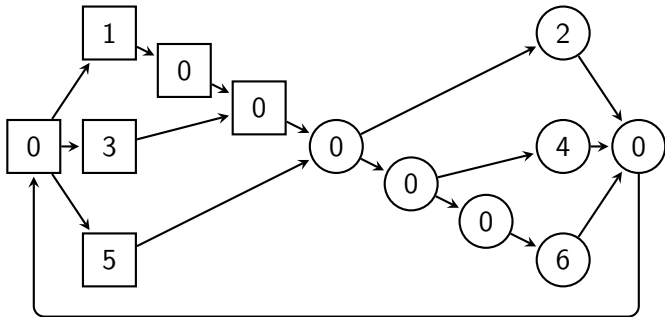

(Fijalkow and Chatterjee, Infinite-state games, 2013)

Memory Requirements (for Player 0)

Theorem

Optimal strategies for parity games require exponential memory.

Sufficiency: Corollary of proof of PSPACE-membership

Necessity: Construct family \mathcal{G}_d :

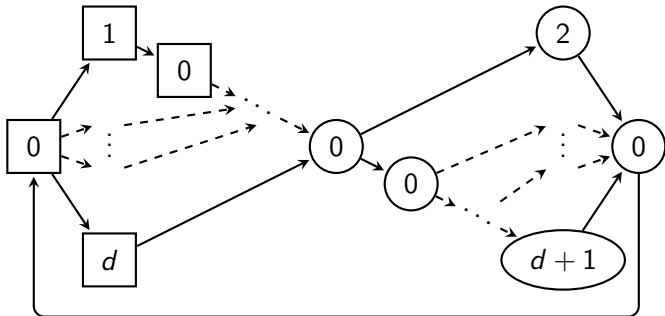

(Fijalkow and Chatterjee, Infinite-state games, 2013)

Memory Requirements (for Player 0)

Theorem

Optimal strategies for parity games require exponential memory.

Sufficiency: Corollary of proof of PSPACE-membership

Necessity: Construct family \mathcal{G}_d :

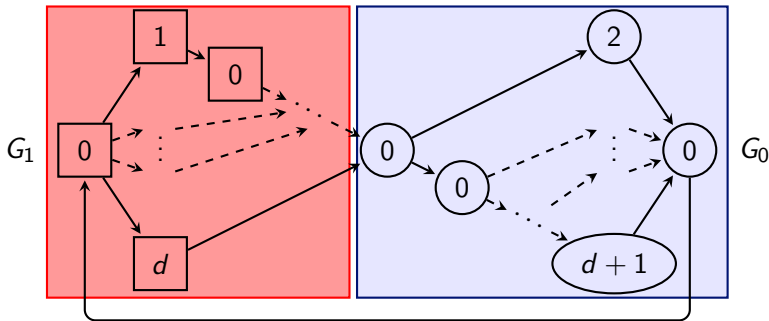

Memory Requirements (for Player 0)

Theorem

Optimal strategies for parity games require exponential memory.

Sufficiency: Corollary of proof of PSPACE-membership

Necessity: Construct family \mathcal{G}_d :

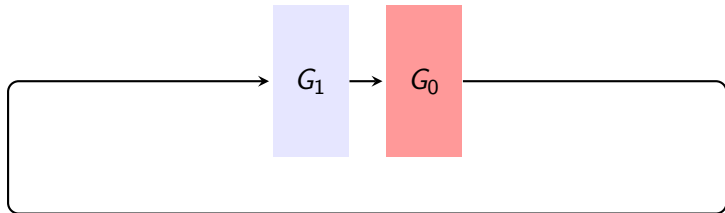

Memory Requirements (for Player 0)

Theorem

Optimal strategies for parity games require exponential memory.

Sufficiency: Corollary of proof of PSPACE-membership

Necessity: Construct family \mathcal{G}_d :

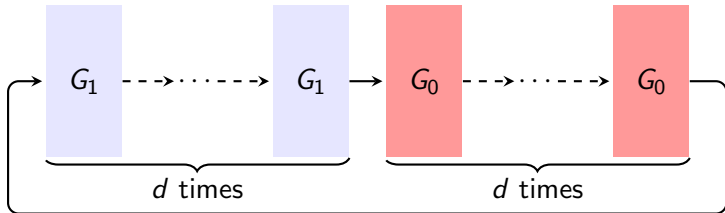

Memory Requirements (for Player 0)

Theorem

Optimal strategies for parity games require exponential memory.

Sufficiency: Corollary of proof of PSPACE-membership

Necessity: Construct family \mathcal{G}_d :

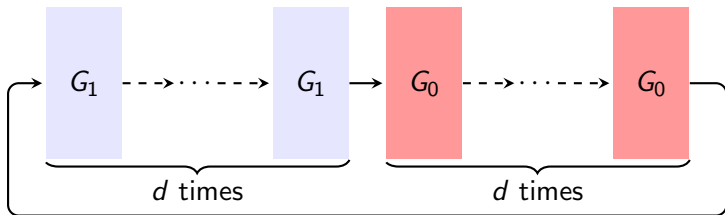

Player 0 needs to store d choices of d possible values each

Memory Requirements (for Player 0)

Theorem

Optimal strategies for parity games require exponential memory.

Sufficiency: Corollary of proof of PSPACE-membership

Necessity: Construct family \mathcal{G}_d :

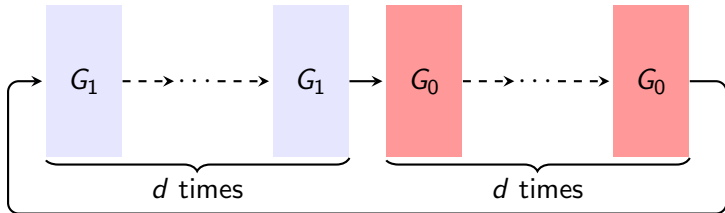

Player 0 needs to store d choices of d possible values each
 \Rightarrow Player 0 requires $\approx 2^d$ many memory states

Introduction ✓



Complexity

in PSPACE ✓

PSPACE-hard ✓



Exponential Memory

Sufficient

Necessary

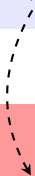

Introduction ✓



Complexity

in PSPACE ✓

PSPACE-hard ✓



Exponential Memory

Sufficient ✓

Necessary ✓

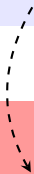

Conclusion

Parity

Complexity	$UP \cap co-UP$
Strategies	1

Conclusion

	Parity	Finitary Parity
		Winning
Complexity	$UP \cap co-UP$	P_{TIME}
Strategies	1	1

Conclusion

	Parity	Finitary Parity	
		Winning	Optimal
Complexity	$UP \cap co-UP$	P_{TIME}	$PSPACE\text{-comp.}$
Strategies	1	1	Exp.

Conclusion

	Parity	Finitary Parity	
		Winning	Optimal
Complexity	$UP \cap co-UP$	P_{TIME}	$PSPACE\text{-comp.}$
Strategies	1	1	Exp.

Take-away: Forcing Player 0 to answer quickly in parity games makes it harder

- to decide whether she can satisfy the bound
- for her to play the game

Introduction ✓



Complexity

in PSPACE ✓

PSPACE-hard ✓



Exponential Memory

Sufficient ✓

Necessary ✓

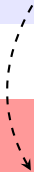

Introduction ✓



Complexity

in PSPACE ✓

PSPACE-hard ✓



Exponential Memory

Sufficient ✓

Necessary ✓



Tradeoffs

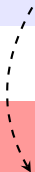

Introduction ✓



Complexity

in PSPACE ✓

PSPACE-hard ✓



Exponential Memory

Sufficient ✓

Necessary ✓



Tradeoffs



Parity Games with Costs

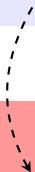

Tradeoffs



Tradeoffs



	Winning	Optimal
Size	1	2^d
Cost	$3d$	$2d$

Tradeoffs



	Winning		Optimal
Size	1	d	2^d
Cost	$3d$		$2d$

Tradeoffs



	Winning		Optimal
Size	1	d	2^d
Cost	$3d$	$3d - 1$	$2d$

Tradeoffs



	Winning			Optimal
Size	1	d	2^{d-1}	2^d
Cost	$3d$	$3d - 1$		$2d$

Tradeoffs



	Winning		Optimal	
Size	1	d	2^{d-1}	2^d
Cost	$3d$	$3d - 1$	$2d + 1$	$2d$

Tradeoffs



	Winning				Optimal
Size	1	d	\dots	2^{d-1}	2^d
Cost	$3d$	$3d - 1$	\dots	$2d + 1$	$2d$

Introduction ✓



Complexity

in PSPACE ✓

PSPACE-hard ✓



Exponential Memory

Sufficient ✓

Necessary ✓



Tradeoffs



Parity Games with Costs

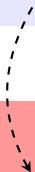

Introduction ✓



Complexity

in PSPACE ✓

PSPACE-hard ✓



Exponential Memory

Sufficient ✓

Necessary ✓



Tradeoffs ✓



Parity Games with Costs

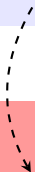

Parity Games with Cost

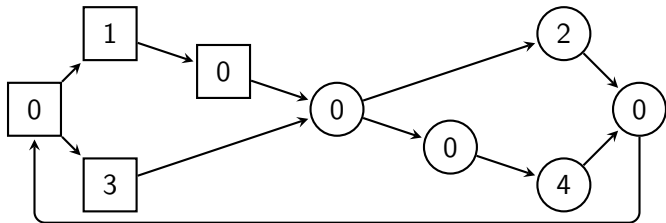

Parity Games with Cost

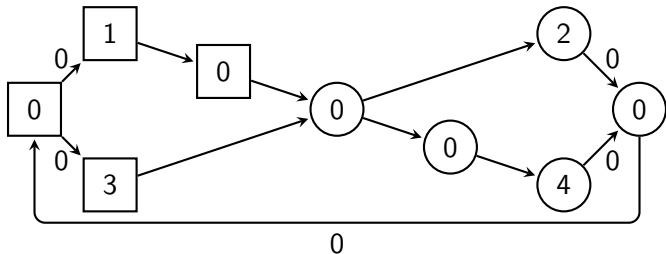

Parity Games with Cost

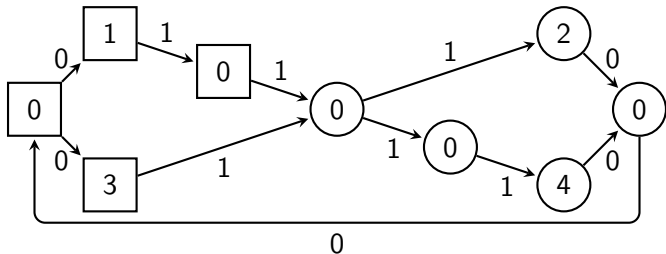

Parity Games with Cost

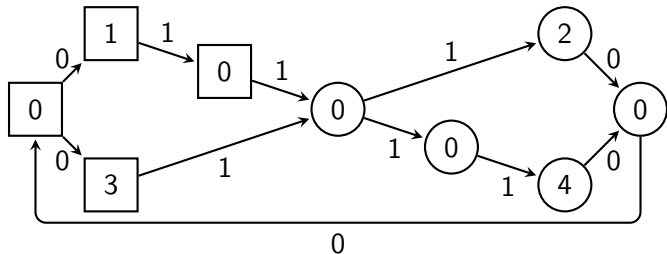

Finitary parity games are special case

Parity Games with Cost

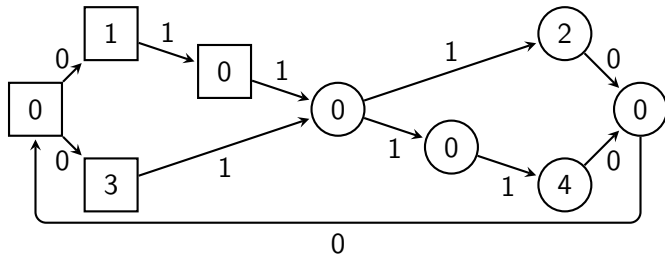

Finitary parity games are special case

⇒ PSPACE-hard

⇒ Exp. memory necessary

Parity Games with Cost

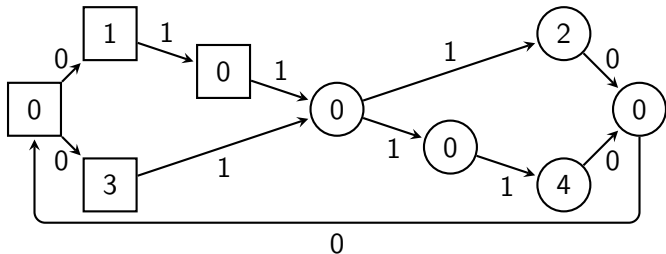

Finitary parity games are special case

\Rightarrow PSPACE-hard \Rightarrow Exp. memory necessary

Algorithm for solving finitary games works as well

Parity Games with Cost

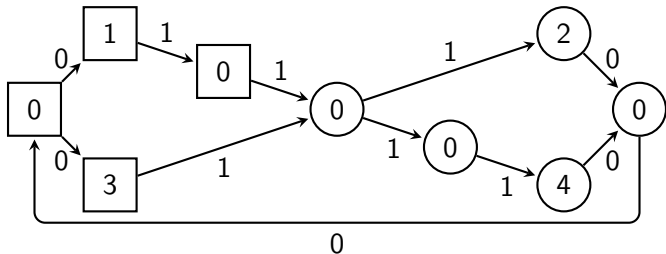

Finitary parity games are special case

⇒ PSPACE-hard ⇒ Exp. memory necessary

Algorithm for solving finitary games works as well

⇒ In PSPACE ⇒ Exp. memory sufficient

Conclusion

Parity

Complexity	$UP \cap co-UP$
Strategies	1

Conclusion

	Parity	Cost-Parity
	Winning	
Complexity	$UP \cap co-UP$	$UP \cap co-UP$
Strategies	1	1

Conclusion

	Parity	Cost-Parity	
		Winning	Optimal
Complexity	$UP \cap co-UP$	$UP \cap co-UP$	$PSPACE\text{-}comp.$
Strategies	1	1	Exp.

Conclusion

	Parity	Cost-Parity	
		Winning	Optimal
Complexity	$UP \cap co-UP$	$UP \cap co-UP$	$PSPACE\text{-}comp.$
Strategies	1	1	Exp.

Take-away: Forcing Player 0 to answer quickly in parity games makes it harder

- to decide whether she can satisfy the bound
- for her to play the game